

PROFILES EXTRUDES

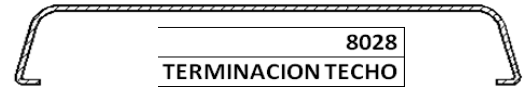

8033
PERFIL VALLA CONCAVO

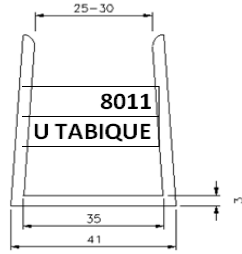
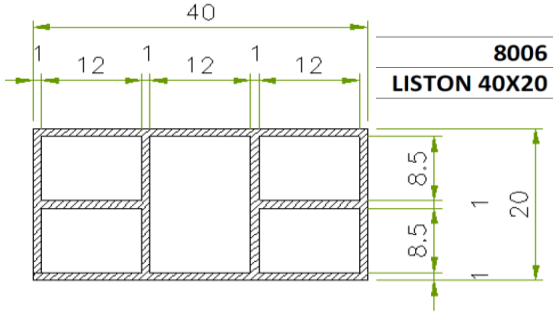
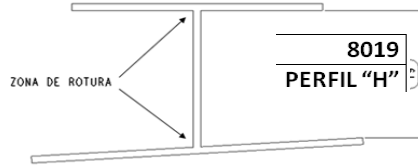
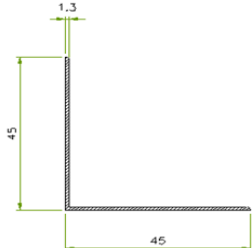
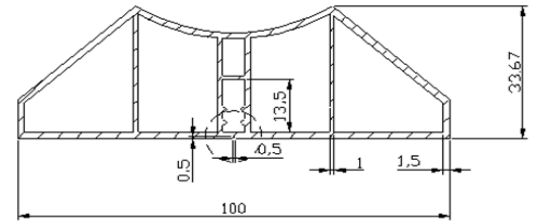

8039
TRIANGULO REFUERZO

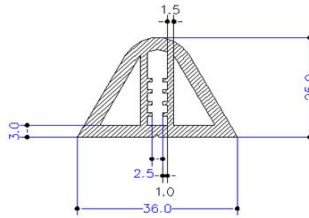

8034
PERFIL VALLA CONVEXO

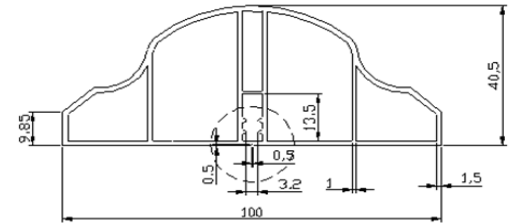

8013
CANTONERA 45X45 (RECOGE GOTAS)

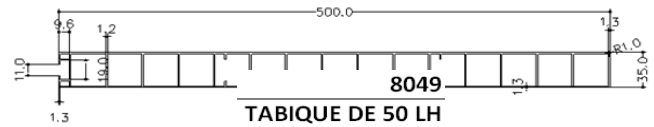
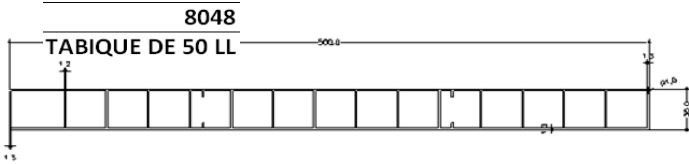
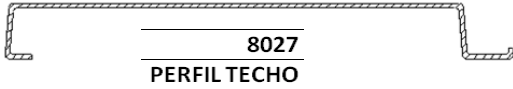

8056
PERFIL INVERNADERO

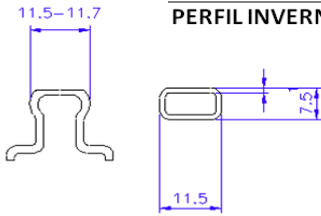

8059
PERFIL 55X35 EGAIN

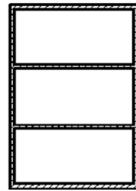

ESQUEMA DE MONTAJE

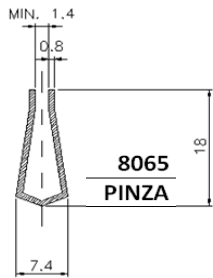
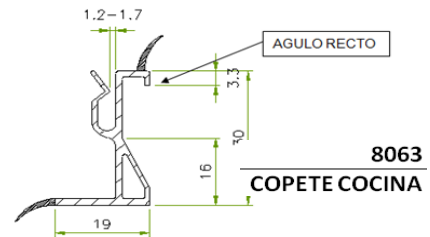

8066
PERFIL U BISAGRA TRASERA

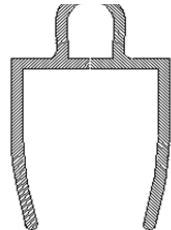

8067
PERFIL U BISAGRAS LATERALES

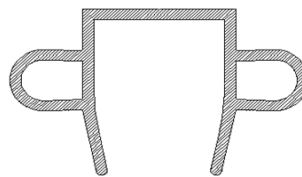

8074
COPETE 1122

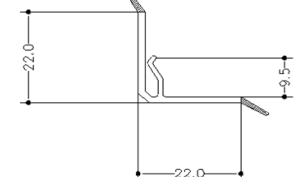

PROFILES EXTRUDES

8078
PANEL 250X20

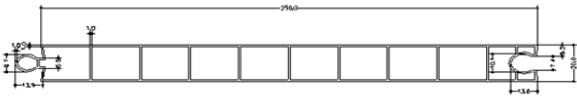

8090
EXPANEL DE 500 MH

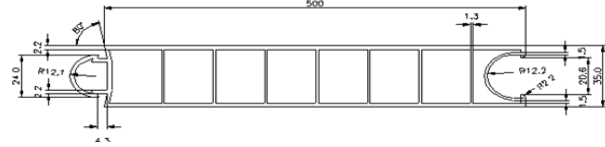

8091
EXPANEL DE 500 LH



8092
EXPANEL DE 500 LM

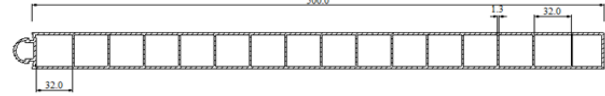

8094
EXPANEL DE 200 MH

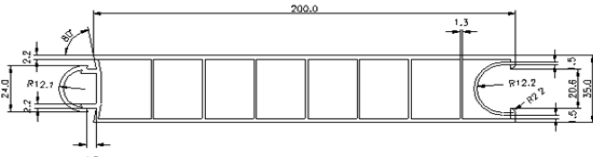

8095
EXPANEL DE 200 LH

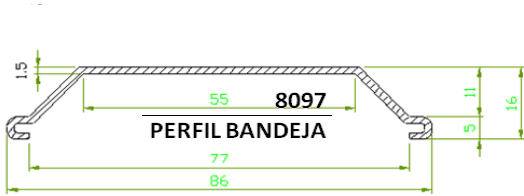
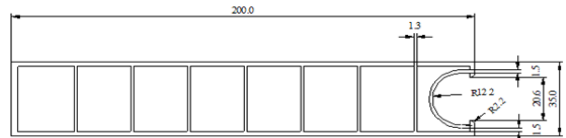

8098
PERFIL VALLA MONDO

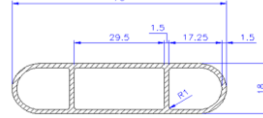

8202
PERFIL TAPON ADAPTADOR POSTE

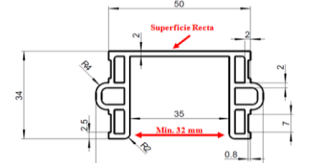

8330
PINZA SEMIRIGIDA

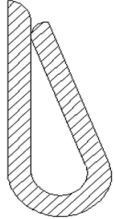

8503
PANEL CALPER

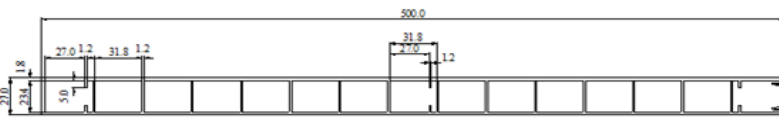

8504
TAPA CALPER

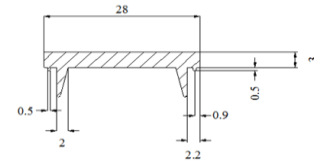

8519
CUADRADILLO 22X22X1.5

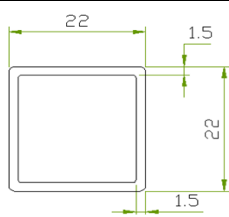

8524
L 45X37

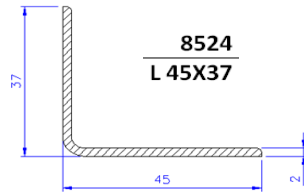

8539
U LOMEÑA

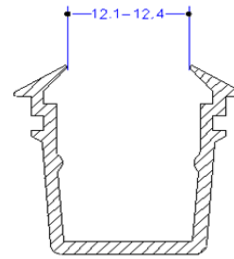

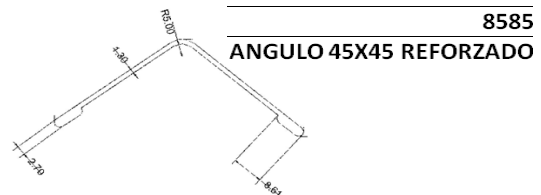
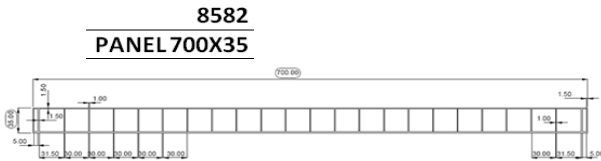
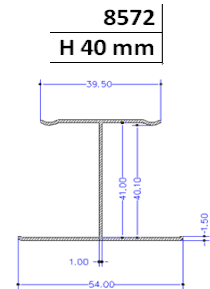
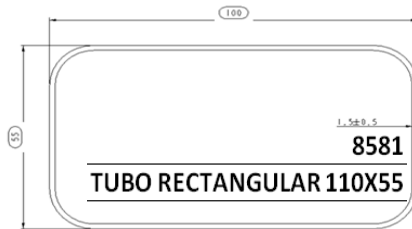
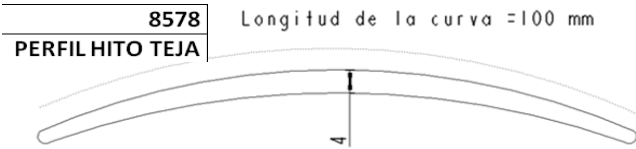
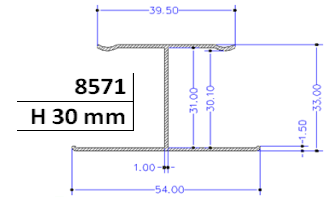
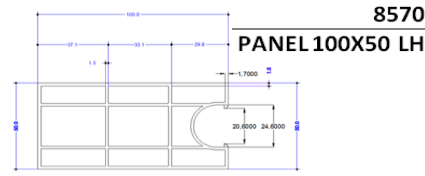
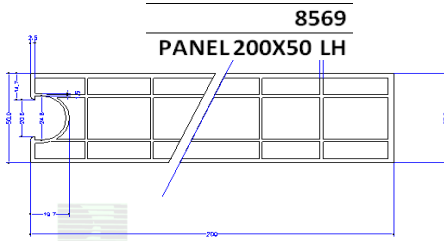
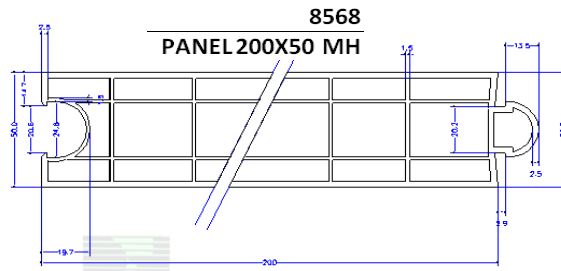
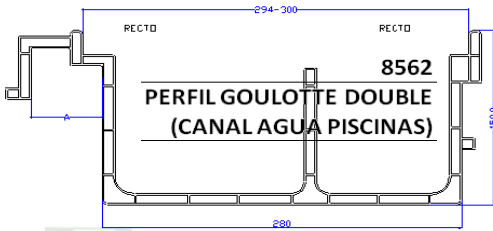
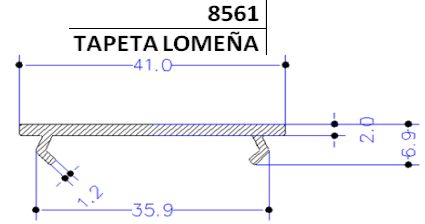
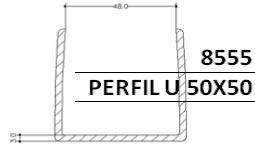
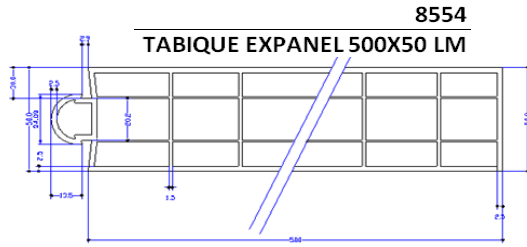
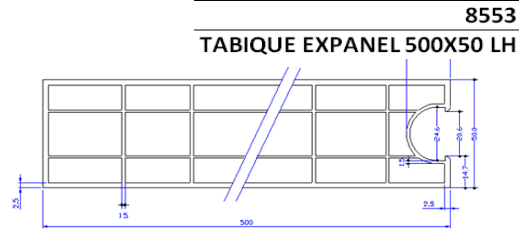
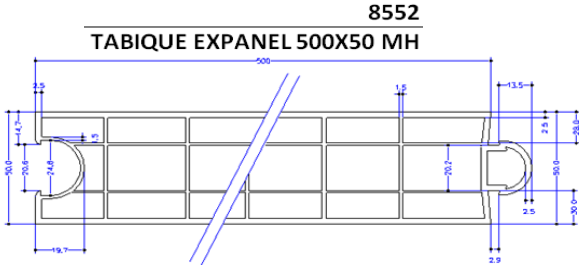

PROFILES EXTRUDES

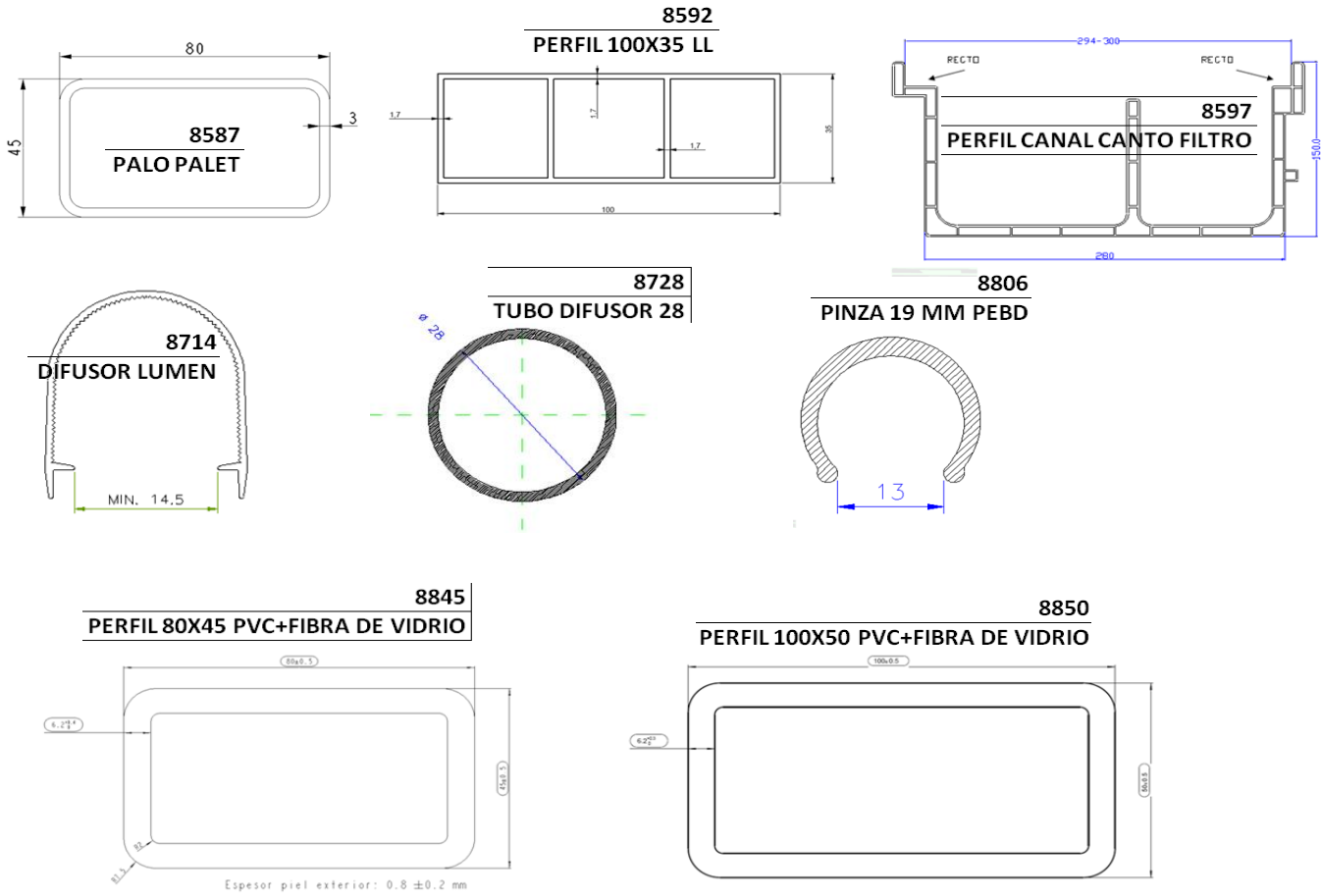

Expertise - Conception - Réalisation

EXPERTISE INJECTION PLASTIQUE et ALUMINIUM
CONCEPTION - REALISATION PIECES & OUTILLAGES
OUTILLAGES LASER TRACKER LTS-Express
FABRICATION PIECES MECANIQUES
MISE AU POINT MOULES INJECTION
NEGOCE

NOUVEAU SITE INTERNET : www.chronomold.com